

PRODUCT DATASHEET

Confidex NFC Sticker™ for non-metal surfaces



High quality NFC Sticker on reel format with various IC options

ELECTRICAL SPECIFICATION

Device type

NFC Forum Type 2

Air interface protocol

ISO 14443A

Operational frequency

13,56 MHz

IC type

NXP NTAG213

Infineon my-d move NFC

Memory configuration

NTAG213: User memory 144 Bytes

my-d move NFC: User memory 128 Bytes

Read range*

Mobile phone up to 45mm

Fixed reader up to 90mm

Applicable surface materials*

Non-metallic surfaces.

* Read ranges are measured in laboratory environment and there can be some variation in real application. Also used surface material and IC type might affect the read range.

MECHANICAL SPECIFICATION

Tag materials

Printable white synthetic face layer, resin ribbon recommended.

Background adhesive

Permanent adhesive for general purpose use.

Weight

0,2 g

Delivery format

2000 pcs on reel

Pitch on reel

38,1 mm / 1.5"

Reel core inner diameter

76 mm / 3"

Tag dimensions

40 x 35 x 0,2 mm / 1.57 x 1.38 x 0.01 in

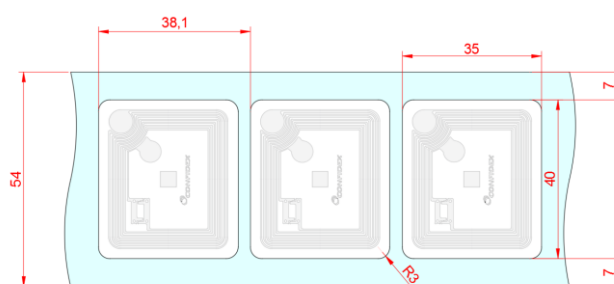

Tag structure

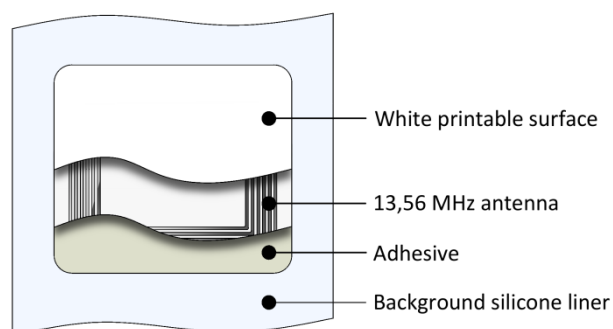

ENVIRONMENTAL RESISTANCE

Operating temperature

-20°C to +60°C / -4°F to +140°F

Ambient temperature

-20°C to +60°C / -4°F to +140°F

Water resistance

Good, tested 5 hours in 1m deep water (IP68)

Chemical resistance

No physical or performance changes in:

- 168h Salt water (salinity 10%) exposure
- 168h Sulfuric acid (10%, pH 2) exposure
- 168h Motor oil exposure
- 2h NaOH (10%, pH 13) exposure
- 2h Acetone exposure

Storage condition

1 year in +20°C / 50% RH (shelf life for adhesive)

Expected lifetime

Years in normal operating conditions

Values in the table are the best recommendations; resistance against environmental conditions depends on the combination of all influencing factors, exposure duration and chemical concentrations. Thus, product's final suitability for certain environmental conditions is recommended to be tested. Contact Confidex for more specific information.

PERSONALIZATION OPTIONS

Pre-encoding

- Customer specific encoding.

Artwork printing

- Full color artwork is printed on top of the product.

Visual data

- Customer specific layout including variable text, numbers, barcodes etc.

INSTALLATION INSTRUCTIONS

Ideal installation conditions are +20°C (+68°F) / 50% RH. For exceptional conditions, please contact Confidex. Bond strength can be improved with firm application pressure. Always ensure clean surface for obtaining the maximum bond strength.

During attachment to the identified item, please avoid touching the background adhesive. If the location on the asset needs to be changed, please use a new tag instead of re-placing the used one; the adhesion will suffer from the re-placement.

Minimum bending diameter of the Confidex NFC Sticker™ is defined to be 50mm. Do not bend the label above the limit. Never touch on the location of the IC. IC chip is sensitive electrical component and can be damaged if unexpected pressure is applied on the chip.

ORDER INFORMATION

Product number: 3000570

Product name: Confidex NFC Sticker™ MDM (white, non-metal)

Product number: 3001252

Product name: Confidex NFC Sticker™ NTAG213 (white, non-metal)

For other versions, additional information and technical support contact Confidex Ltd.

DISCLAIMER

THE MATERIALS, PRODUCTS AND SERVICES ARE SOLD SUBJECT TO ITS STANDARD CONDITIONS OF SALE, WHICH ARE INCLUDED IN THE APPLICABLE DISTRIBUTOR OR OTHER SALES AGREEMENT. ALTHOUGH ANY INFORMATION, RECOMMENDATIONS, OR ADVICE CONTAINED HEREIN IS GIVEN IN GOOD FAITH, CONFIDEX MAKES NO WARRANTY OR GUARANTEE, EXPRESS OR IMPLIED, (i) THAT THE RESULTS DESCRIBED HEREIN WILL BE OBTAINED UNDER END-USE CONDITIONS, OR (ii) AS TO THE EFFECTIVENESS OR SAFETY OF ANY DESIGN INCORPORATING ITS PRODUCTS, MATERIALS, SERVICES, RECOMMENDATIONS OR ADVICE. EXCEPT AS PROVIDED IN CONFIDEX STANDARD CONDITIONS OF SALE, CONFIDEX AND ITS REPRESENTATIVES SHALL IN NO EVENT BE RESPONSIBLE FOR ANY LOSS RESULTING FROM ANY USE OF ITS MATERIALS, PRODUCTS OR SERVICES DESCRIBED HEREIN.

Each user bears full responsibility for making its own determination as to the suitability of Confidex products, materials, services, recommendations, or advice for its own particular use. Each user must identify and perform all tests and analyses necessary to assure that its finished systems incorporating Confidex products, materials, or services will be safe and suitable for use under end-use conditions. Nothing in this or any other document, nor any oral recommendation or advice, shall be deemed to alter, vary, supersede, or waive any provision of this Disclaimer, unless any such modification is specifically agreed to in a writing signed by Confidex.

