



The DS2100N is the ideal compact laser bar code scanner with complete connectivity and communication options for close reading applications.

The DS2100N is available in distinct models offering on-board PROFINET, EtherNet/IP, and Ethernet TCP/IP communication protocols. With on-board Ethernet ports and switch capability, the DS2400N can be networked into PROFINET line or ring topologies for system redundancy. With EDS-AOP setup tools, configuring the EtherNet/IP fieldbus communication is simple and easy. Through PROFINET, the DS2400N can be configured via the modular structure contained in the GSDML file. Parameters are stored in the GSDML file, providing automatic configuration for failed or replaced devices.

With an innovative rotating connector block, the DS2100N minimizes its mechanical dimensions offering a flexible form factor during installation.

Embedded switches, dual PROFINET parts, and a rotating connector block are a few of the unique features that define the Datalogic DS2x00N family. Additionally, innovative software features provide easy and simple scanner installation and replacement.

The DS2100N is equipped with the latest generation microprocessor powering an improved code reconstruction algorithm delivering superior performance on low quality codes or damaged labels.



IDENTIFICATION



HIGHLIGHTS

- Embedded Ethernet connectivity
- Two PROFINET Ports
- Embedded Ethernet Switch
- Line topology
- Rotating connector block
- Compact dimensions
- Installation flexibility and optimum form factor
- ACR: Advanced Code Reconstruction
- Excellent performance on low quality and damaged labels
- Up to to a 300 mm (11.8 in.) reading distance

APPLICATIONS

- Automatic warehouses
- Factory automation
- Automatic picking systems
- Process control and packaging
- Print & apply systems

TECHNICAL DATA

INDUSTRIAL LASER BAR CODE SCANNERS	DS2100N-12XX	DS2100N-13XX	DS2100N-14XX
Reading Distance (Min / Max)		50 - 300 mm (1.97 - 11.81 in)	
Max Resolution		up to 0.12mm (5 mils)	
Scan Rate		500 - 1000 scans/s	
Scan Pattern Type		Linear / Raster	
Aperture Angle		60 degrees	
Multilabel Reading		Up to 10 Codes in the same reading phase	
Reconstruction Code Technology		ACR Advanced Code Reconstruction	
Readable Codes	Code 12of5, Code39, Code93, Code128, EAN/UPC, EAN128, Codabar, Pharmacode, Plessey, ISBT128		
Case Material	Aluminum		
Dimensions (Typical Value)	84 x 68 x 34 mm (3.3 x 2.7 x 1.3 in)	104 x 69 x 38 mm (4.1 x 2.7 x 1.5 in)	104 x 86 x 38 mm (4.1 x 3.4 x 1.5 in)
Weight	330g (11.64 oz)	281 g (10 oz.)	308 g (10.9 oz.)
Temperature Range	0° - 45 °C (32 - 113 °F)		
Voltage Supply/Power Consumption	10-30 VDC; 4 W (average)		
IP Rating	IP65		
Embedded Communication Interfaces	Main port RS232/RS422/RS485 Auxiliary port RS232 ID-NET RS485 multidrop	EtherNet/IP, Ethernet TCP/IP Main port RS232/RS422/RS485 Auxiliary port RS232 ID-NET RS485 multidrop	PROFINET, Ethernet TC/PIP
Digital Inputs	2 Input (optocoupled, NPN/PNP)	2 Input (optocoupled, NPN/PNP)	Not Applicable / Via PROFINET Fieldbus
Digital Outputs	2 Outputs (optocoupled)	2 Outputs (non-optocoupled)	Not Applicable / Via PROFINET Fieldbus
Id-Net™ Interface		✓	
Fieldbus	✓ with CBX, QLM external devices	Embedded EtherNet/IP / compatible with CBX, QLM external devices	Embedded PROFINET with internal switch (2 Ports)
EtherNet	✓ with CBX, QLM external devices	Embedded Ethernet TCP/IP / compatible with CBX, QLM external devices	Embedded PROFINET with internal switch (2 Ports)
Xpress Interface™		✓	
Device Programming	Genius™ (Windows™ based) SW		

ACCESSORIES

ACCESSORY	DESCRIPTION	PN
OM2000N	Oscillating Mirror	93ACC1783
GFC-200	85° Contact Reading Mirror	93A201108
GFC-2100	2KN 90° Lateral Output Window	93A201000
GFC-2020	102° Lateral Output Mirror	93ACC1871

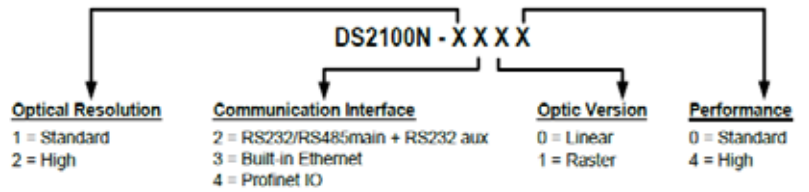

DIMENSIONS

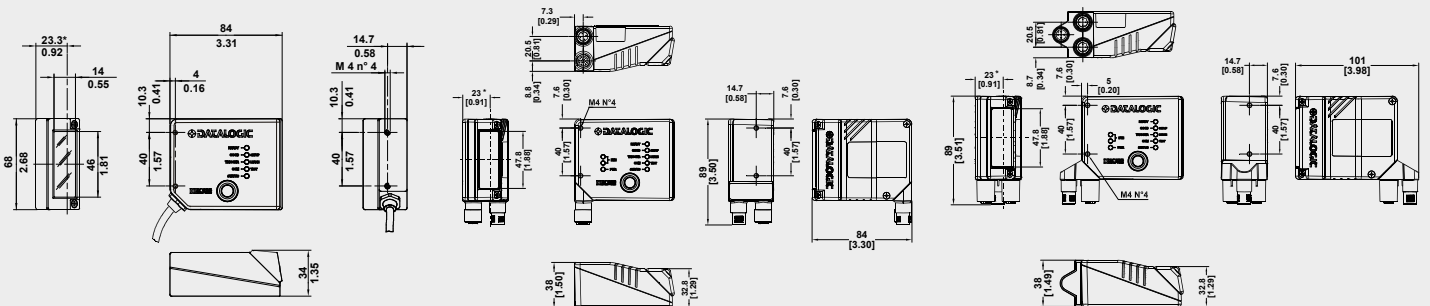

READING DIAGRAMS

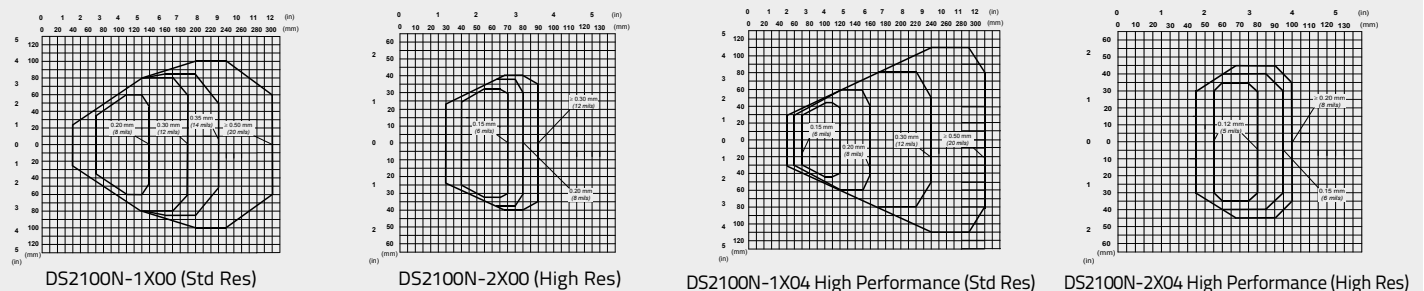

Rev. 02, 11/2014





BARCODE
FACTORY

Barcode Factory

A Paragon Print Systems Company

2021 Paragon Drive | Erie PA 16510
814.456.8331 | Toll Free: 888.237.8525
info@barcodefactory.com