

PIMinator™ Series

Low PIM In-building Omni MIMO Antenna with 500 mm Plenum rated Pigtail and NF Connector

Pulse Part Number DASLTE500NFMIMO

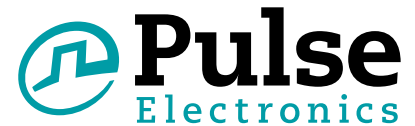

Industry leading -155 dBc certified low Passive Inter-Modulation (PIM) Distributed Antenna System (DAS) In-Building ceiling mount omni MIMO antennas. The Pulse Electronics line of DAS in-building low PIM omni antennas meets the most demanding PIM requirements for 2G, 3G, and LTE/4G bands.

These low PIM antennas help meet increasing demand for high data rates and streaming video for mobile devices. The wide band design meets the needs of operators around the world.

Features

- Multiple input / multiple output (MIMO) provides network carrier greater data rates for improved customer experience.
- Industry leading -155 dBc PIM rating
- Covers cellular bands, WiFi and WiMAX from 698 through 5900 MHz
- Aesthetically pleasing injection molded radome
- PIM certified
- RoHS compliant product
- Patent pending

Applications

- In-Building DAS systems requiring best PIM performance
- Multiple input/multiple output (MIMO) allows fewer antennas in multi-carrier, neutral host applications.

Confidential and Proprietary – Pulse Electronics – All Rights Reserved – 2013

This document contains confidential and proprietary information of Pulse Electronics, Inc. (Pulse) and is protected by copyright, trade secret and other state and federal laws. Its receipt or possession does not convey any rights to reproduce, disclose its contents, or to manufacture, use or sell anything it may describe. Reproduction, disclosure or use without specific written authorization of Pulse is strictly forbidden.

PIMinator™ Series

Low PIM In-building Omni MIMO Antenna with 500 mm Plenum rated Pigtail and NF Connector

Pulse Part Number DASLTE500NFMIMO

Electrical Specifications

| | | |
|--------------------------------|---|---|
| Frequency [MHz] | | 698-960/1710-2170/ 2300-2700/4900-5900 |
| Nominal Impedance [Ω] | | 50 |
| VSWR | 698-960 MHz | 1.7:1 Max |
| | 1710-5900 MHz | 1.7:1 Max |
| Isolation [db] | | < -25 |
| Gain | 698-960 MHz [dBi typ] | 2 |
| | 1710-5900 MHz [dBi typ] | 5 |
| Radiation Pattern | HPBW Horizontal Plane at 45° [°] | 360 |
| | HPBW Vertical Plane (698-960) [° typ] | 85 |
| | HPBW Vertical Plane (1710-2700) [° typ] | 50 |
| | HPBW Vertical Plane (4900-5900) [° typ] | 30 |
| Polarization | | Vertical |
| Power Rating [W] | | 50 |
| PIM at 2x20 Watts [dBc] | | -155 |
| Connector | | N Female |
| Cable Type | | Dia. 0.160" low loss, low PIM, Plenum Rated |
| Cable Length [Inches/mm] | | 19.7 / 500 |

Environmental Specifications

| | |
|----------------------------|------------|
| Operating Temperature [°C] | -40 to +70 |
|----------------------------|------------|

Mechanical Specifications

| | |
|----------------------------|------------------------|
| Radome Material | UV Protected, UL94 V-0 |
| Color | White |
| Weight [oz/g] | 19.04 / 540 |
| Overall Height [Inches/mm] | 4.72 / 120 |
| Length [Inches/mm] | 8.73/222 |
| Width [Inches/mm] | 6.73/171 |
| Mounting | Ceiling |

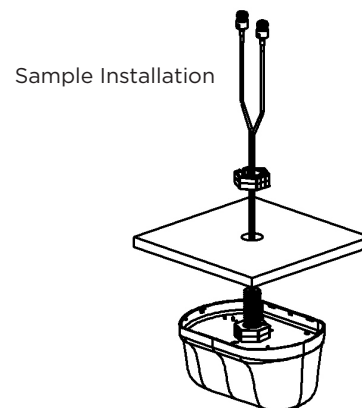

PIMinator™ Series

Low PIM In-building Omni MIMO Antenna with 500 mm Plenum rated Pigtail and NF Connector

Pulse Part Number *DASLTE500NFMIMO*

Radiation Patterns

700MHz - Horizontal Plane

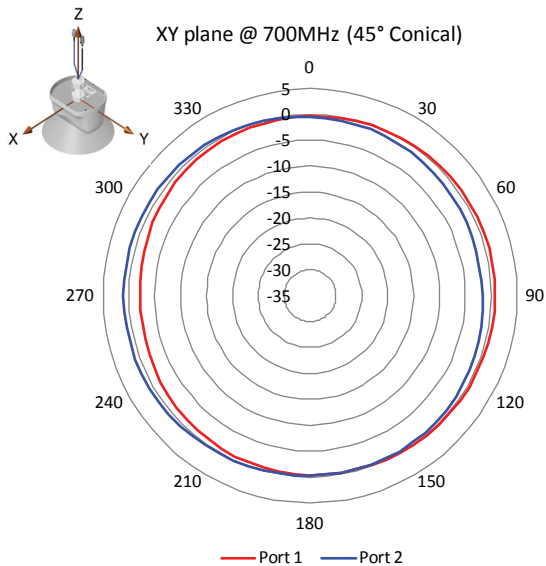

700MHz - Vertical Plane

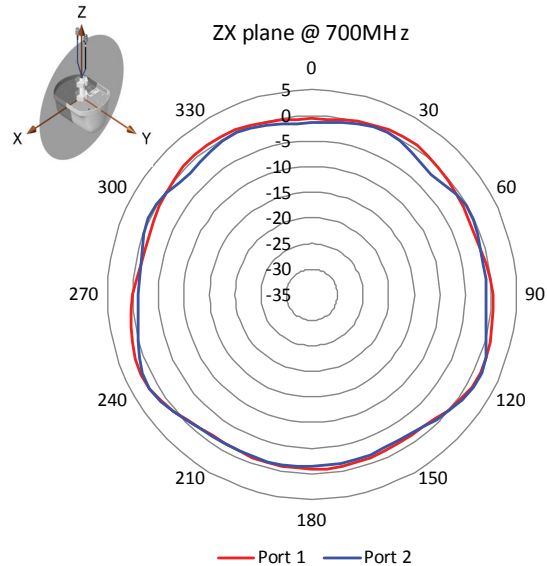

850MHz - Horizontal Plane

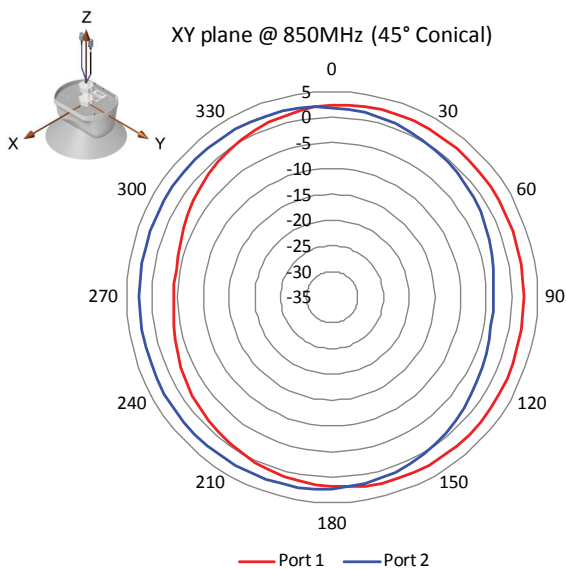

850MHz - Vertical Plane

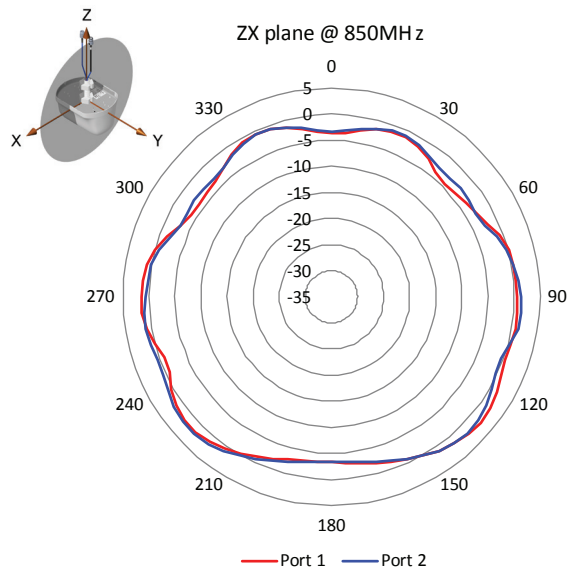

PIMinator™ Series

Low PIM In-building Omni MIMO Antenna

with 500 mm Plenum rated Pigtail and NF Connector

Pulse Part Number DASLTE500NFMIMO

Radiation Patterns

960MHz - Horizontal Plane

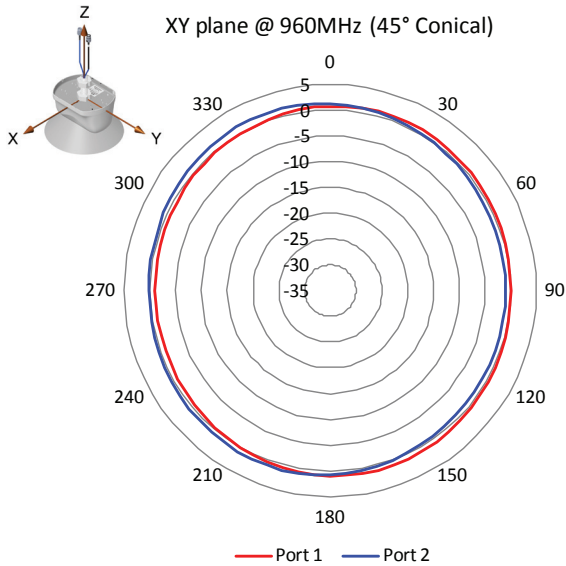

960MHz - Vertical Plane

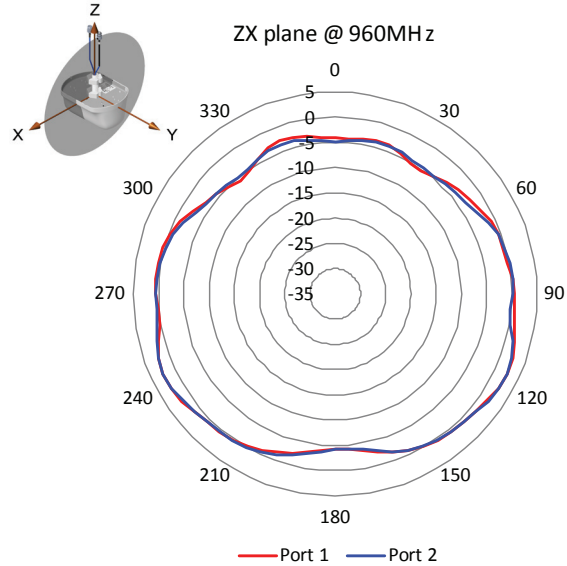

1710MHz - Horizontal Plane

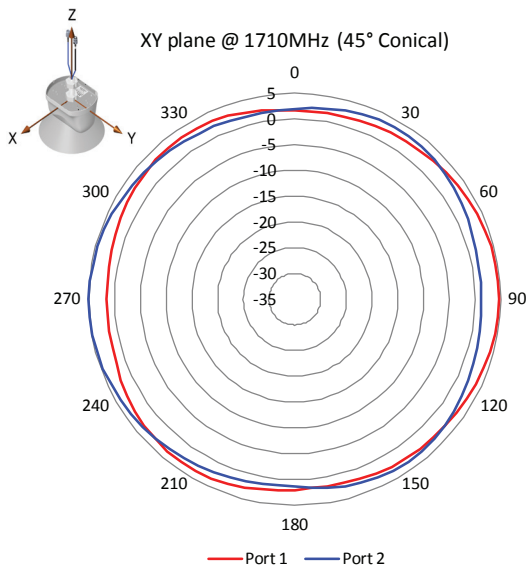

1710MHz - Vertical Plane

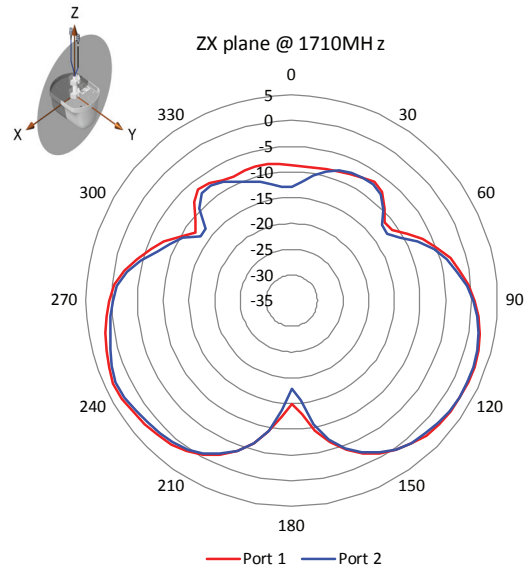

PIMinator™ Series

Low PIM In-building Omni MIMO Antenna with 500 mm Plenum rated Pigtail and NF Connector

Pulse Part Number DASLTE500NFMIMO

Radiation Patterns

1940MHz - Horizontal Plane

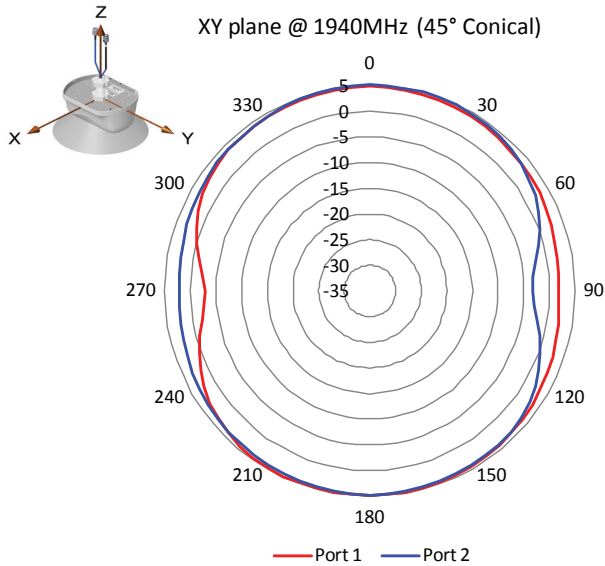

1940MHz - Vertical Plane

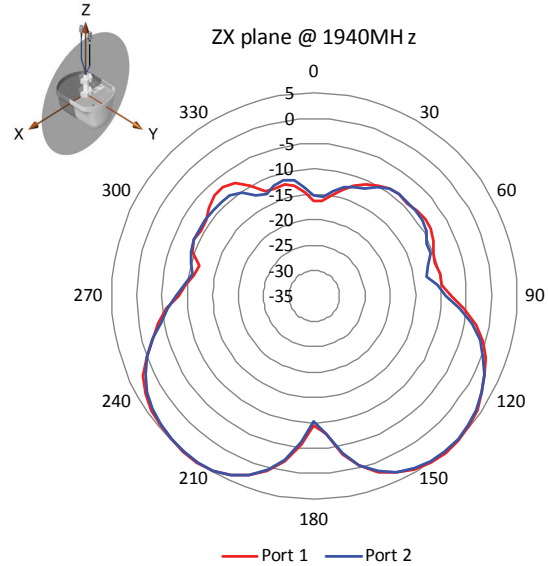

2170MHz - Horizontal Plane

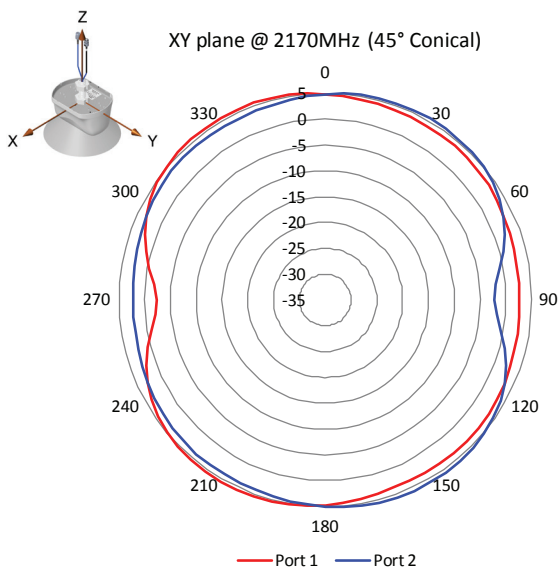

2170MHz - Vertical Plane

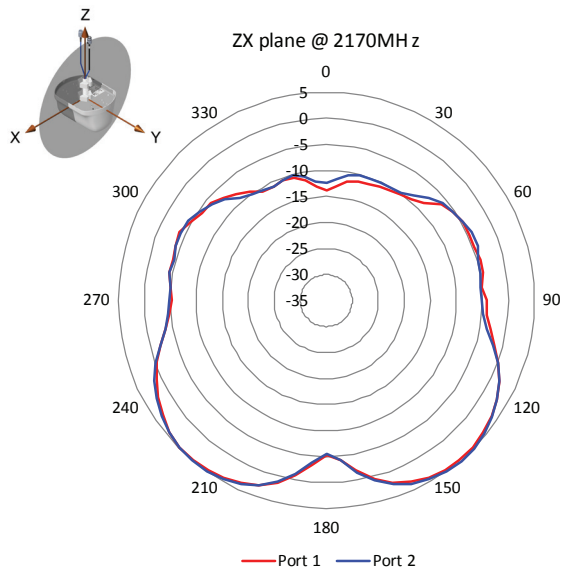

PIMinator™ Series

Low PIM In-building Omni MIMO Antenna with 500 mm Plenum rated Pigtail and NF Connector

Pulse Part Number DASLTE500NFMIMO

Radiation Patterns

2700MHz - Horizontal Plane

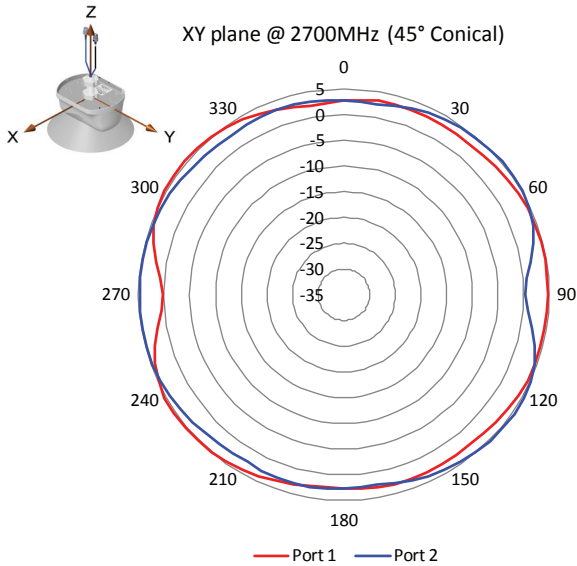

2700MHz - Vertical Plane

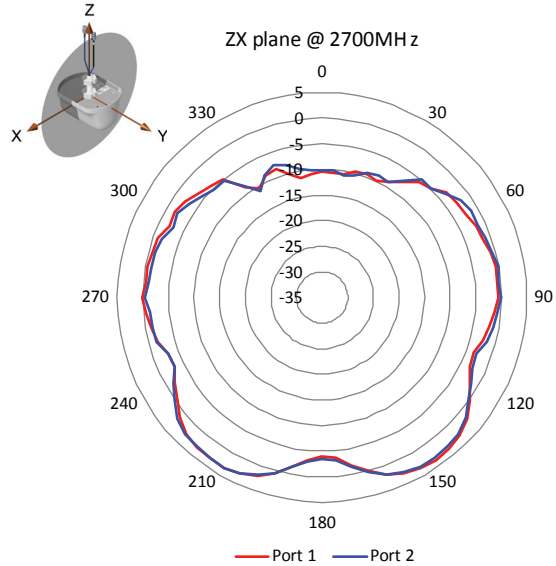

5400MHz - Horizontal Plane

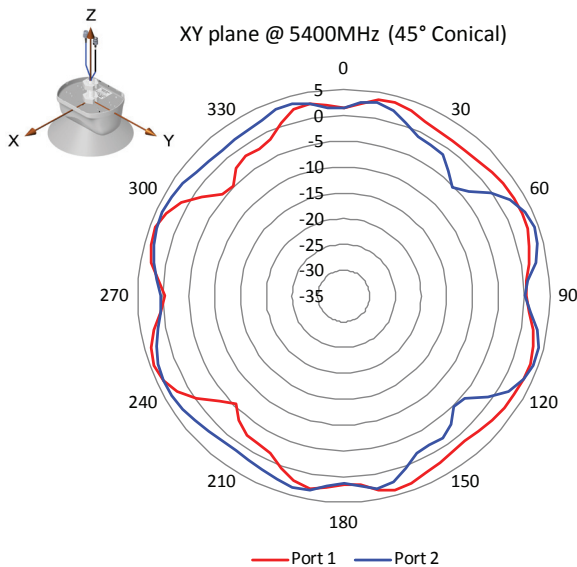

5400MHz - Vertical Plane

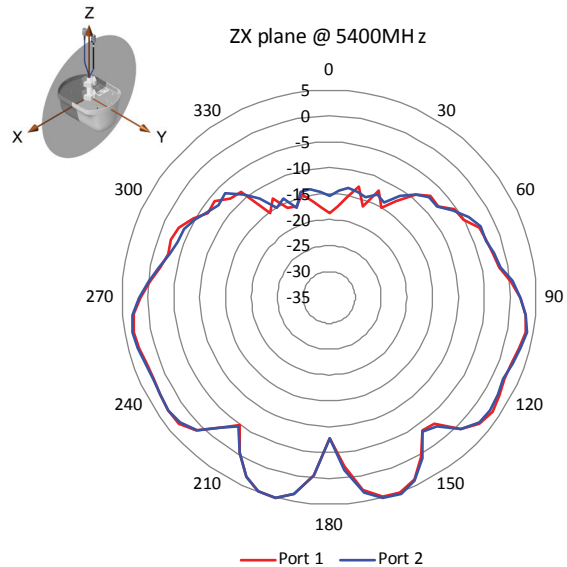

For More Information

Pulse Worldwide Headquarters

12220 World Trade Drive
San Diego, CA 92128
U.S.A.

Larsen Brand Antennas

3611 NE 112th Avenue
Vancouver, WA 98682
USA

Europe Headquarters

Pulse GmbH & Co. KG
Zeppelinstrasse 15
Herrenberg
Germany

Asia Headquarters

B402, Shenzhen Academy of
Aerospace Technology Bldg.
10th Kejian Road, High-Tech Zone
Nanshan District, Shenzhen, PR China 518057

Pulse North Asia

3F, No. 198, Zhongyuan Road
Zhongli City, Taoyuan County 320
Taiwan R. O. C.

Pulse (Suzhou) Wireless Products Co., Inc.

99 Huo Ju Road, (#29 Bldg, 4th Phase)
Suzhou New District
Science & Tech Industrial Park
Jiangsu Province, Suzhou 215009 PR China

Tel: 858 674 8100

Fax: 858 674 8262

Tel: 360 944 7551

Fax: 369 944 7556

Tel: 49 7032 7806 0

Fax: 49 7032 7806 135

Tel: 86 755 33966678

Fax: 86 755 33966700

Tel: 886 3 4356768

Fax: 886 3 4356823

Tel: 86 512 6807 9998

Fax: 86 512 6809 8023

Performance warranty of products offered on this data sheet is limited to the parameters specified. Data is subject to change without notice. Other brand and product names mentioned herein may be trademarks or registered trademarks of their respective owners. © Copyright, 2014, Pulse Electronics, Inc. All rights reserved.